

Gartenhaus aus Holz mit Holzschuppen  
**MASTER 259x213 grün**

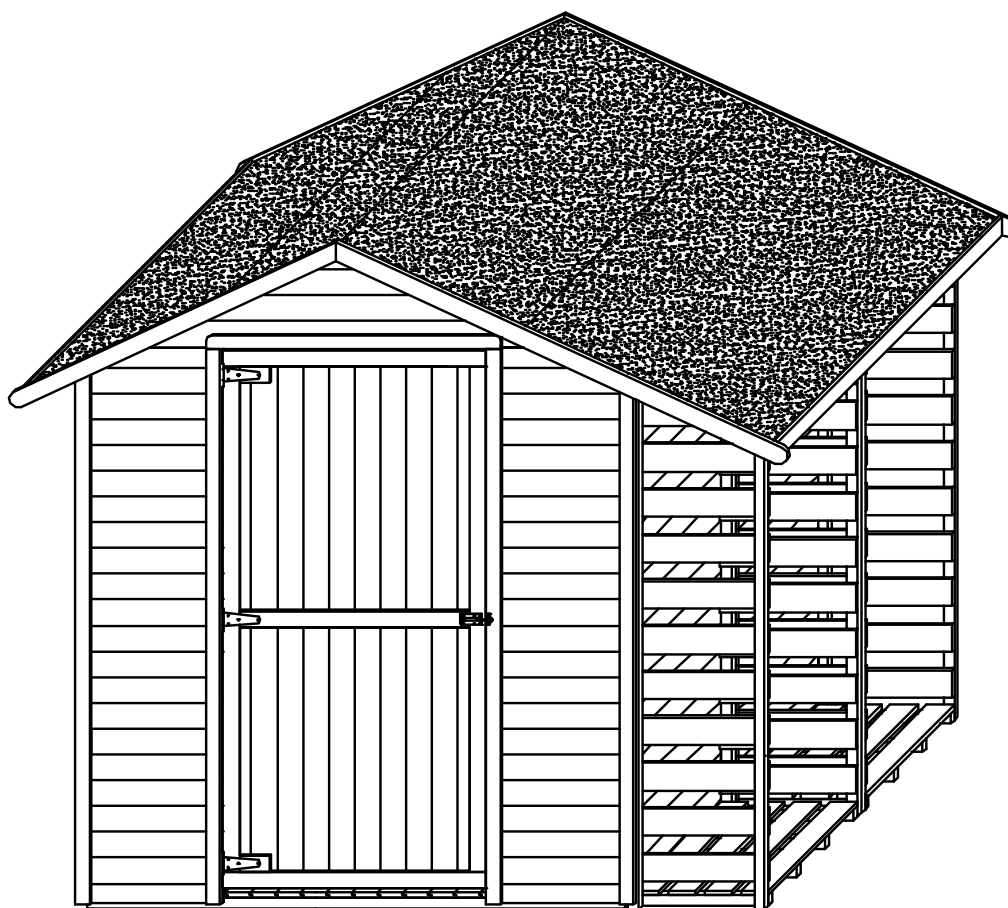

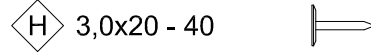
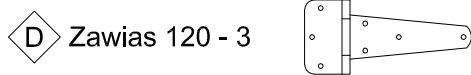
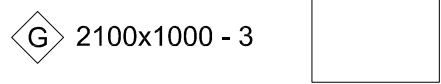
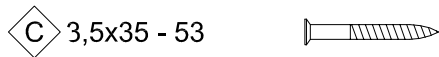
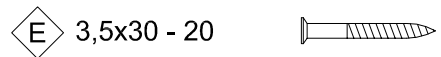
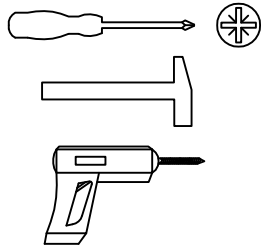
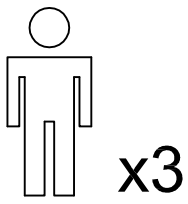

Vor der Montage verfestigen und nivellieren Sie bitte den Boden.  
Vor dem Schraubeneindrehen soll man die Locher bohren.

1

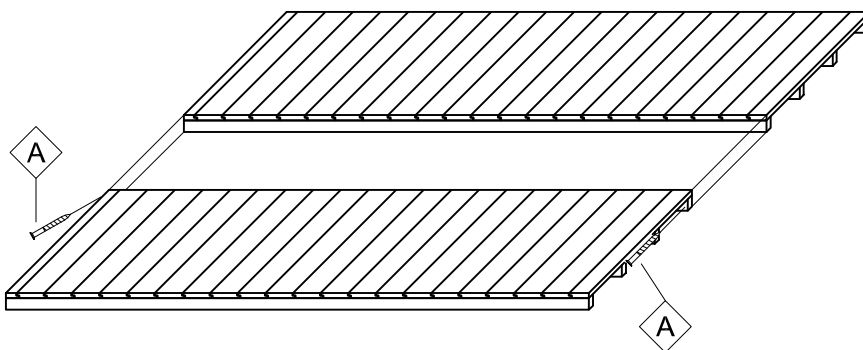

2

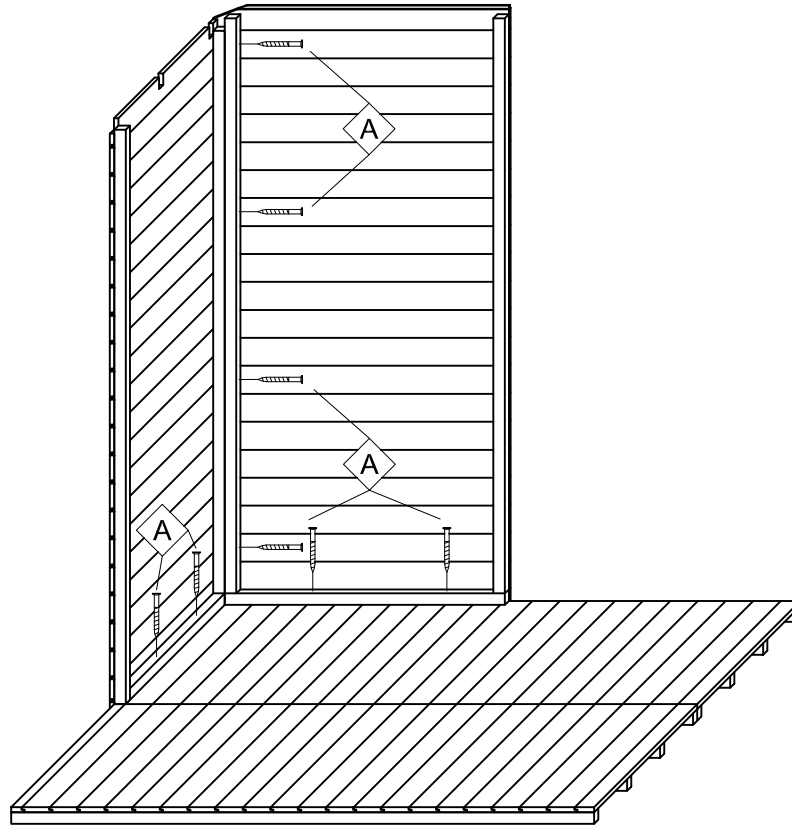

3

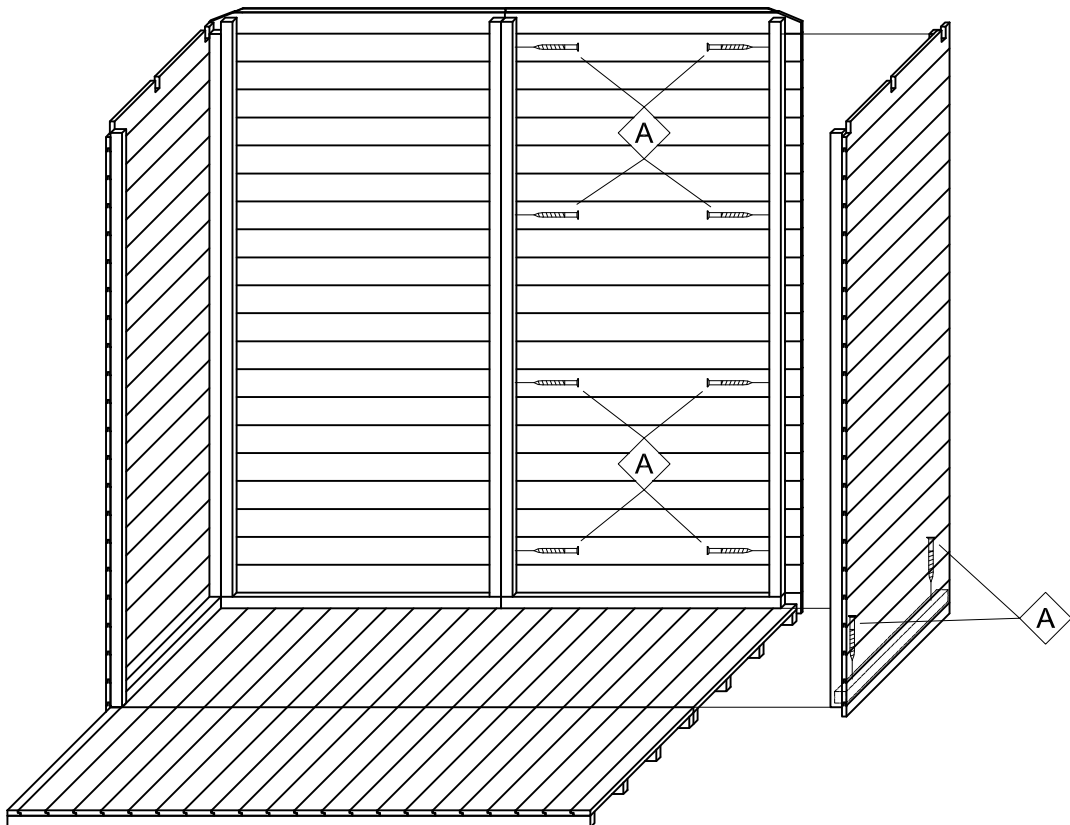

4

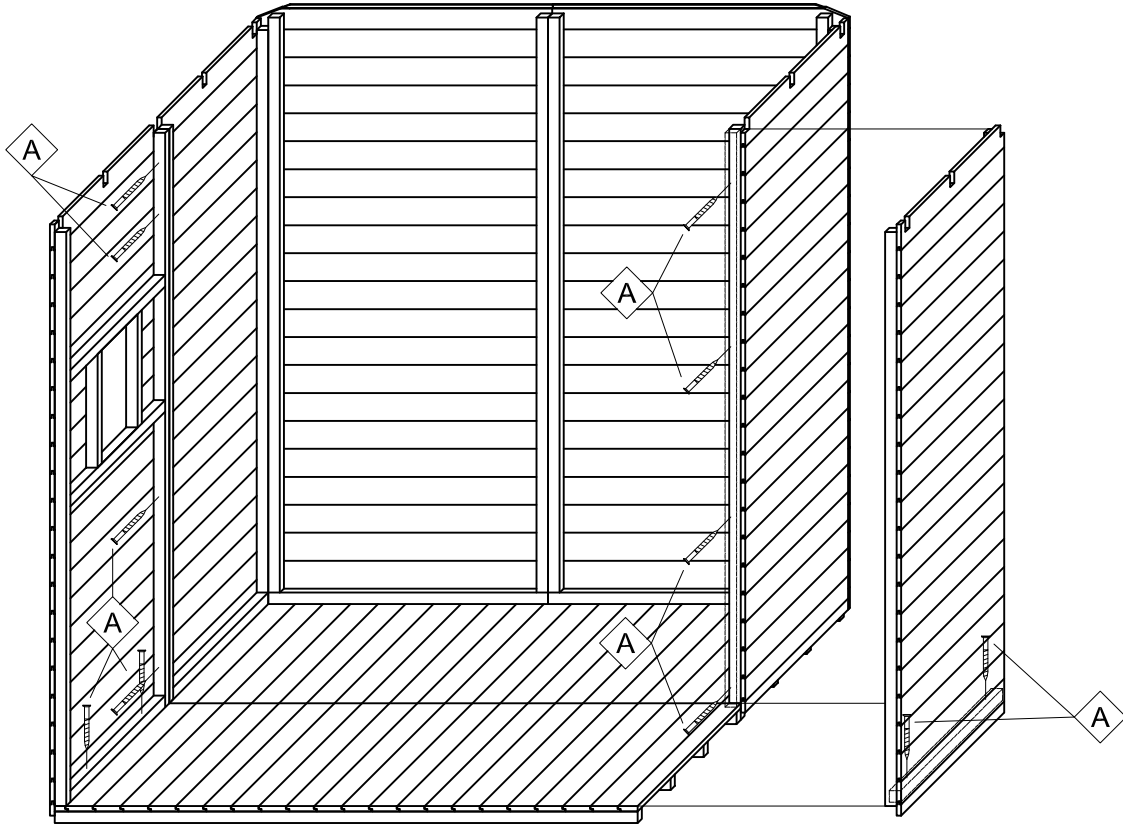

5

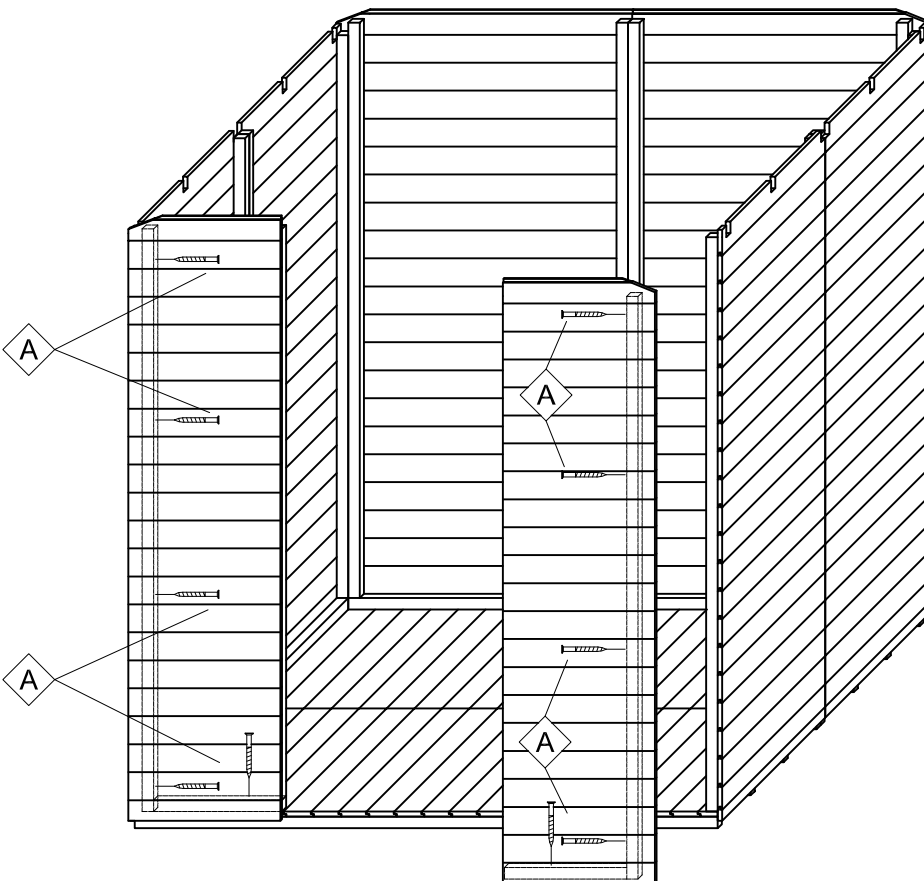

6

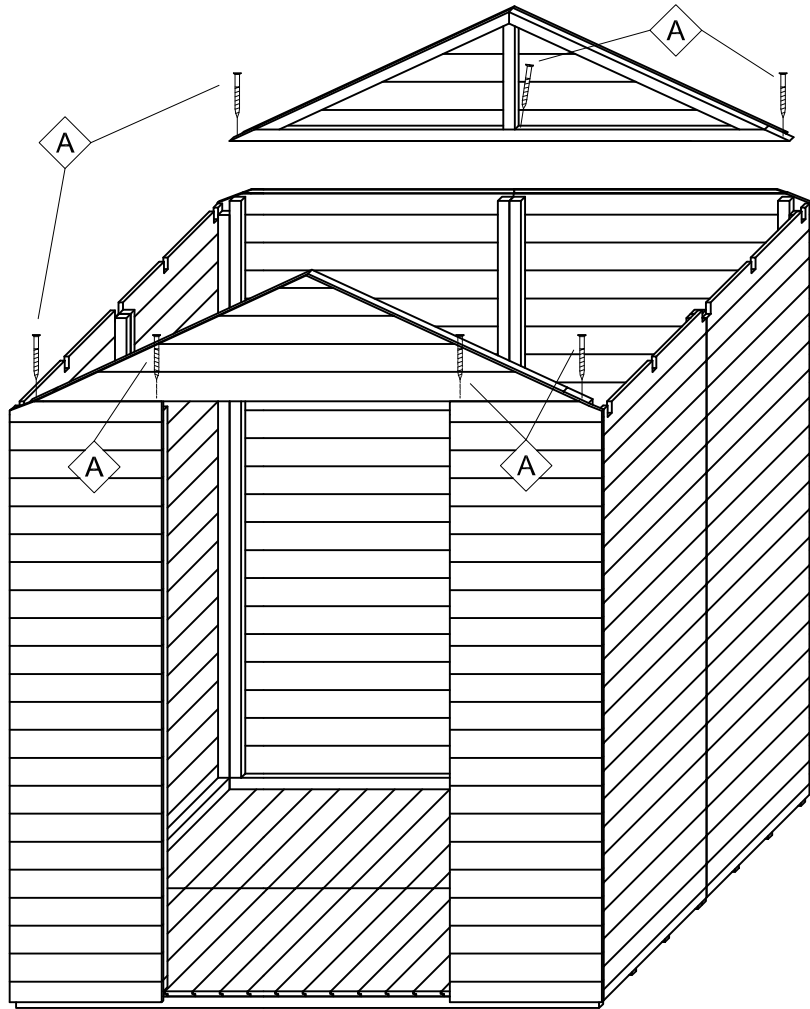

7

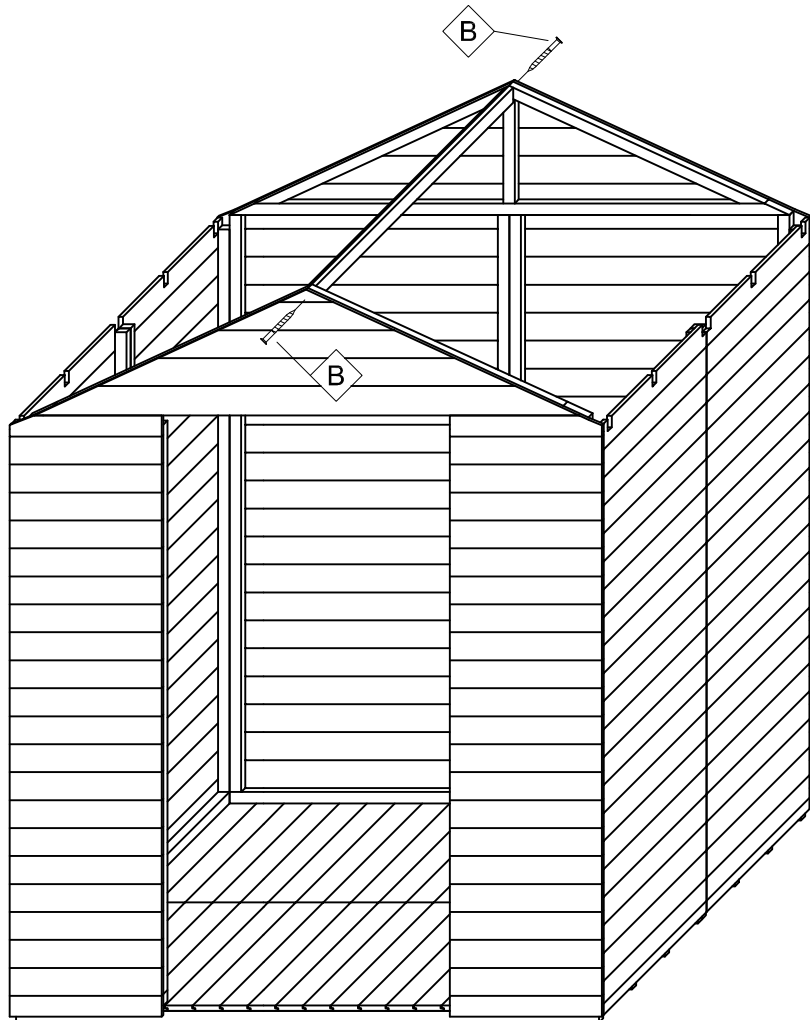

8

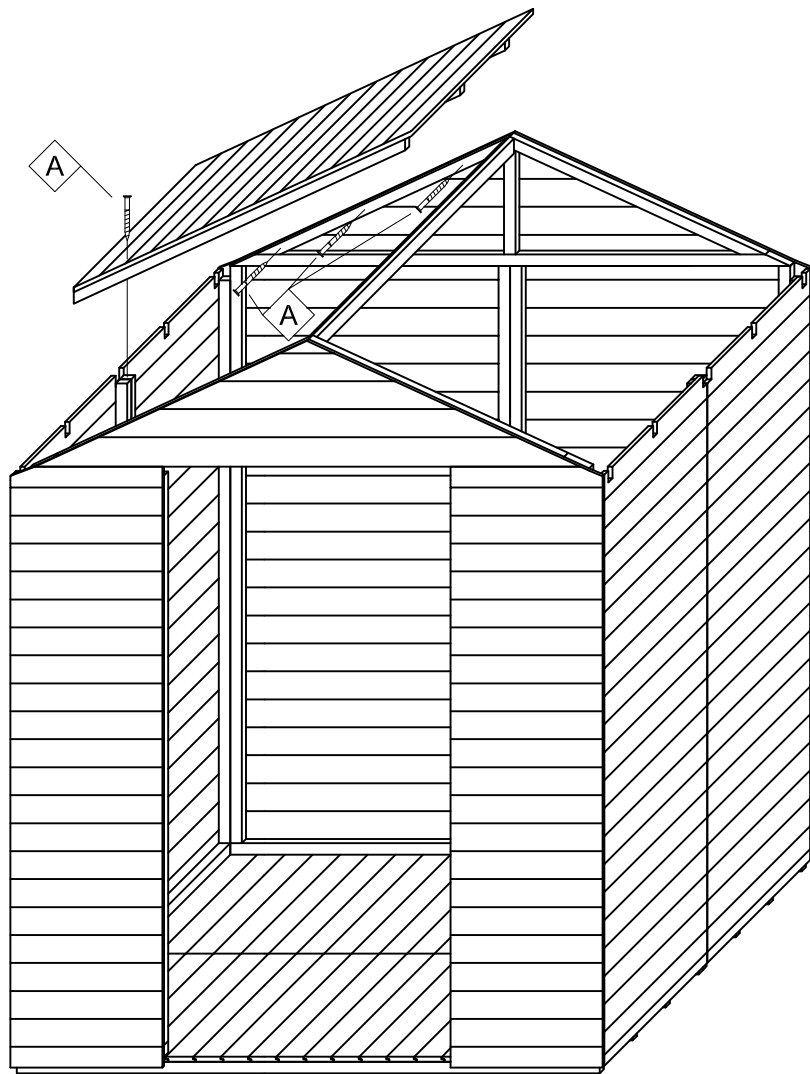

9

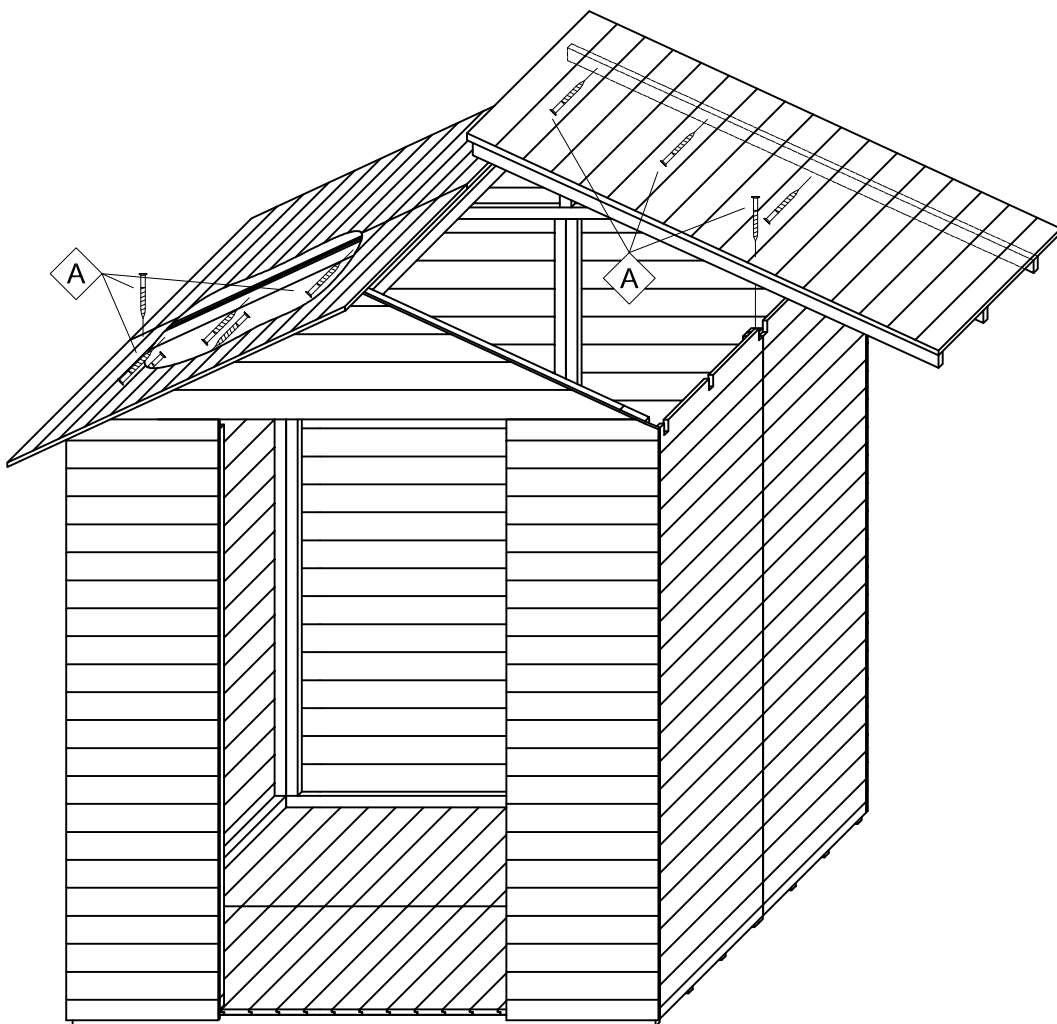

10

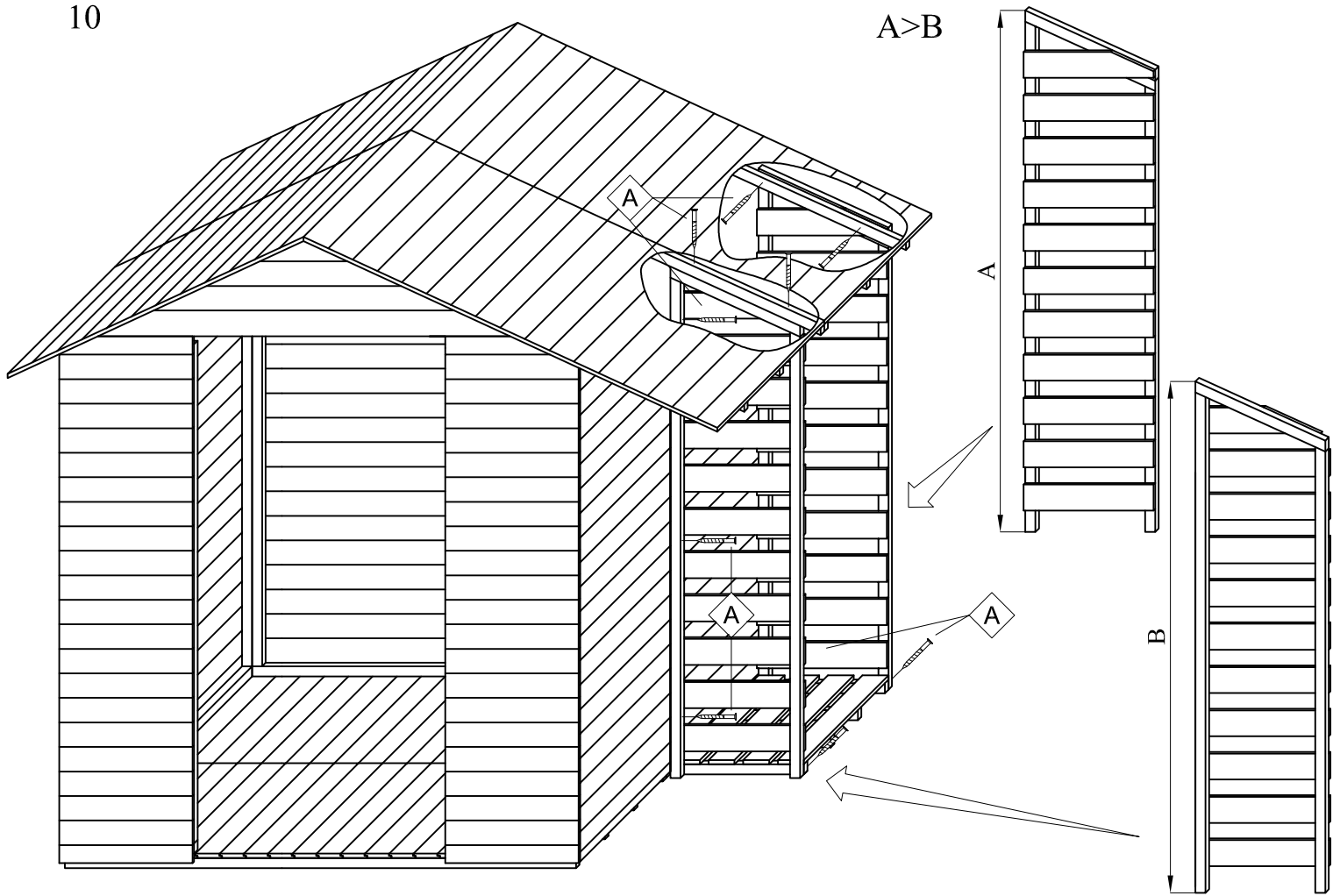

11

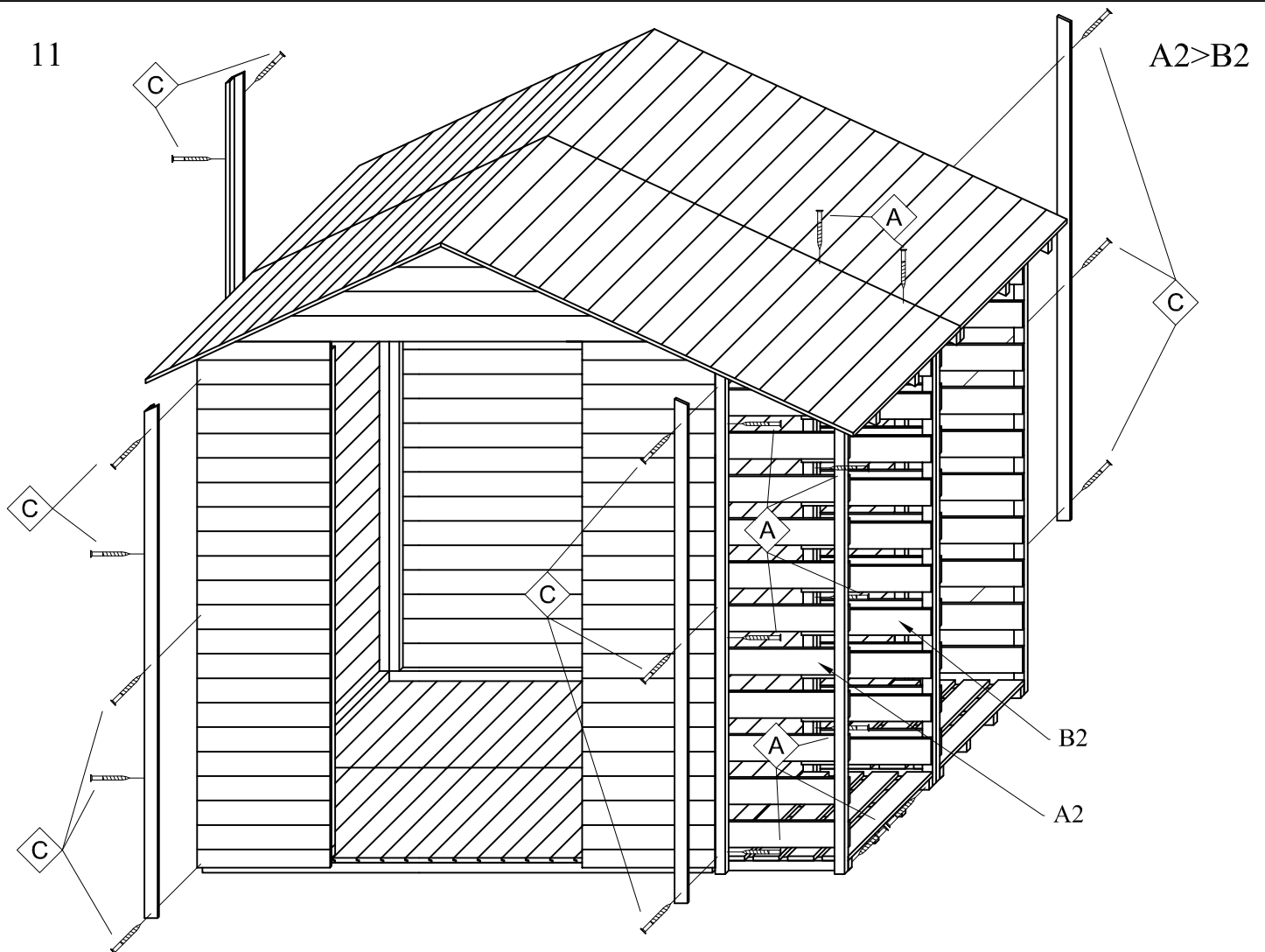

12

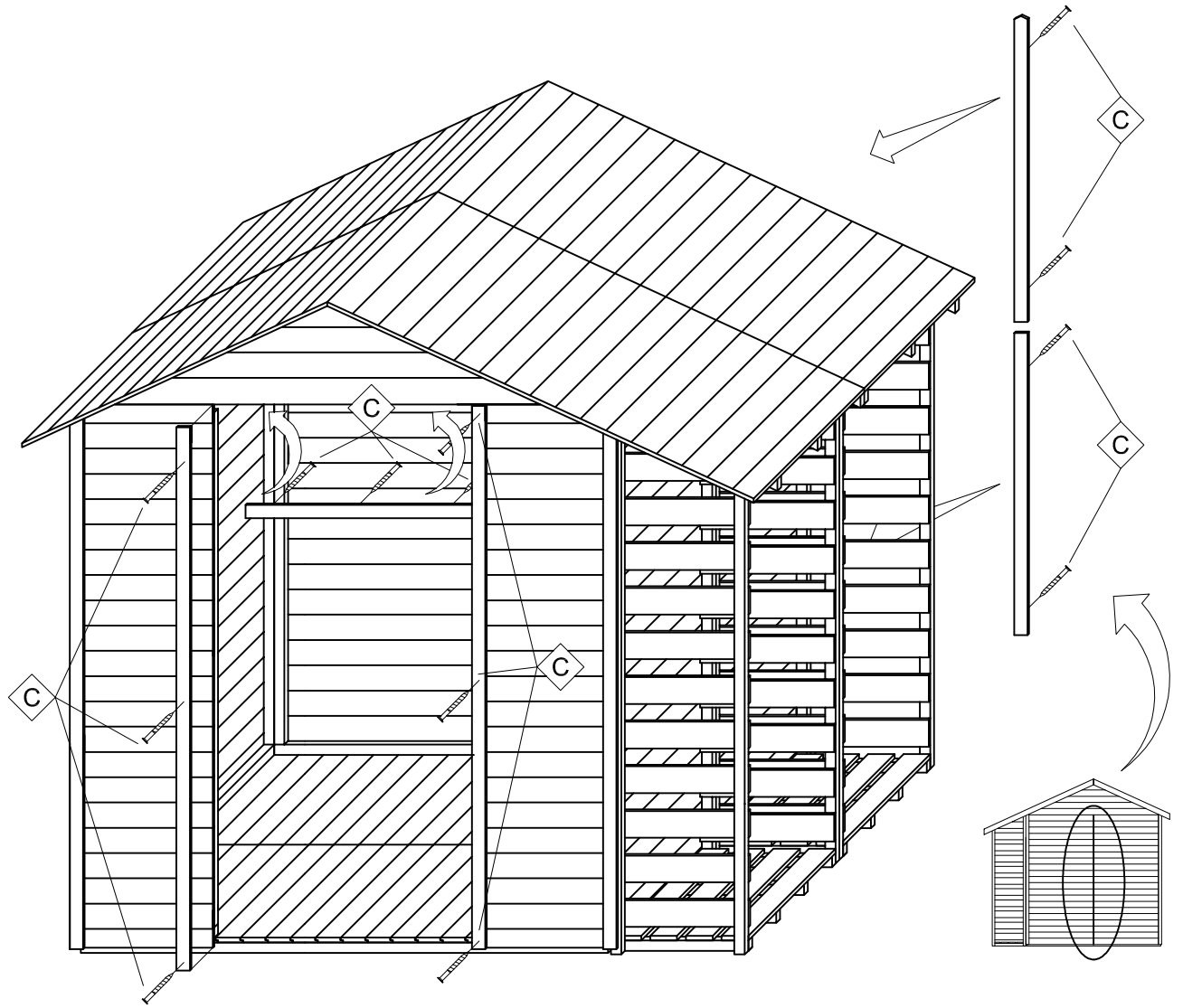

13

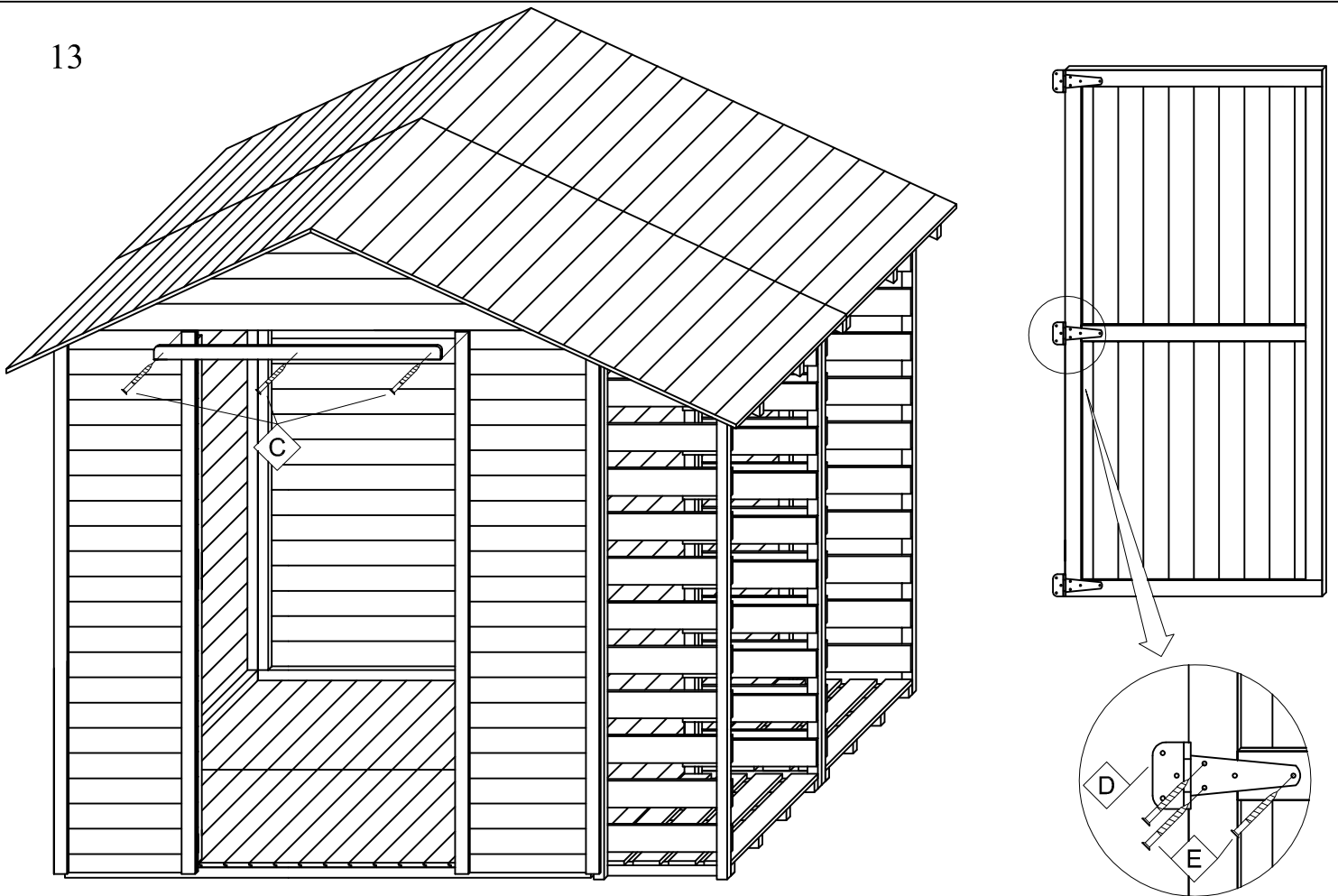



14

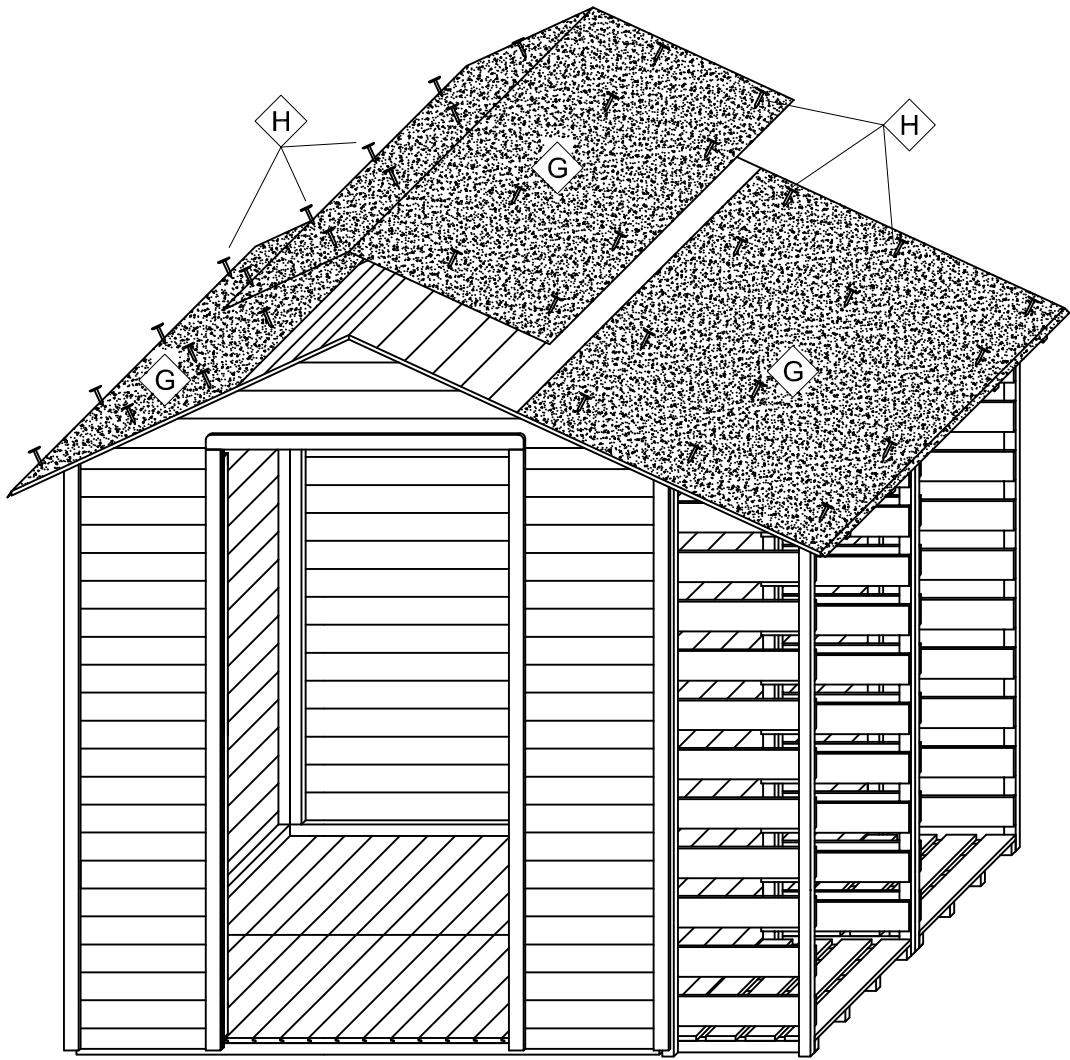

15

