

Gartenhaus aus Holz mit Holzschuppen
MASTER 259x213 braun

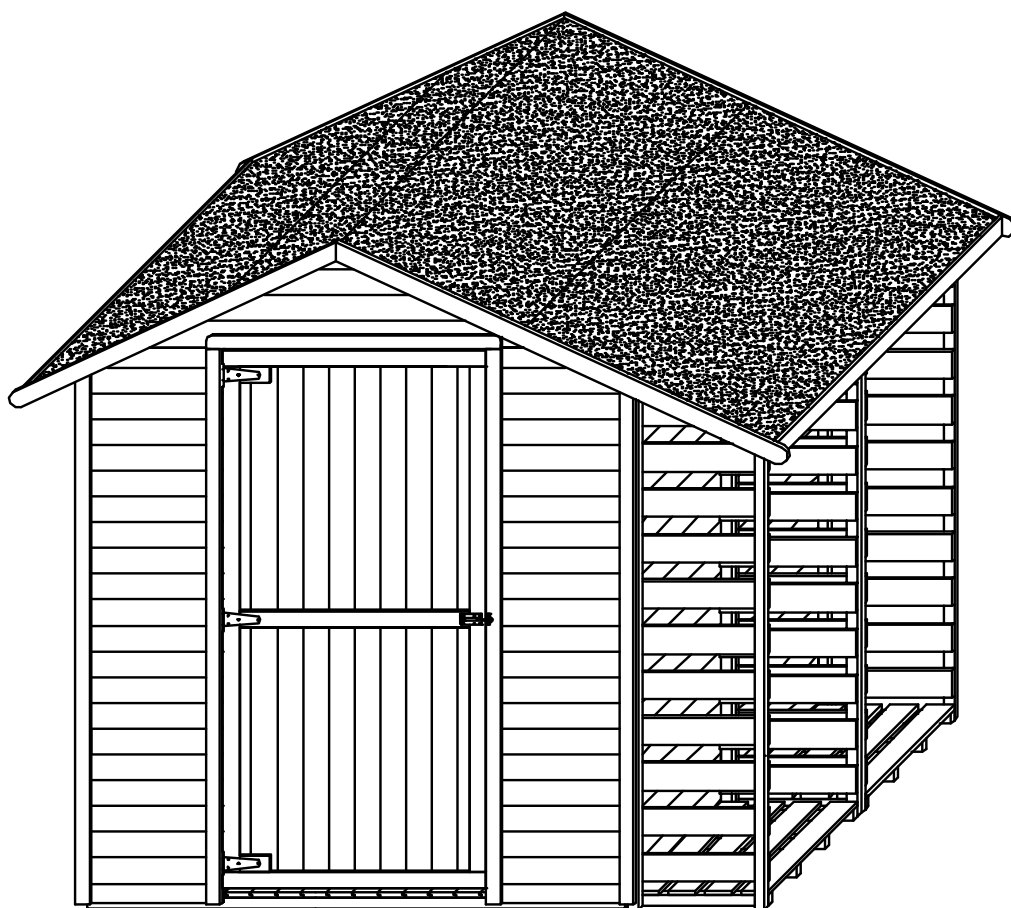

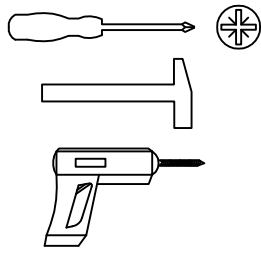

A 4,0x70 - 92

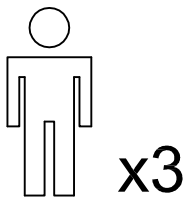
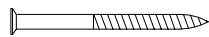

E 3,5x30 - 20

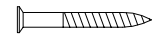

B 5,0x90 - 2

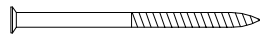

F 80x40 - 1

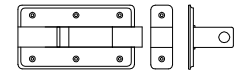

C 3,5x35 - 53

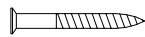

G 2100x1000 - 3

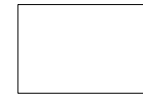

D Zawias 120 - 3

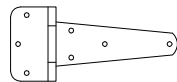

H 3,0x20 - 40



I 4,0x45 - 9

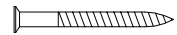

Vor der Montage verfestigen und nivellieren Sie bitte den Boden.
Vor dem Schraubeneindrehen soll man die Locher bohren.

1

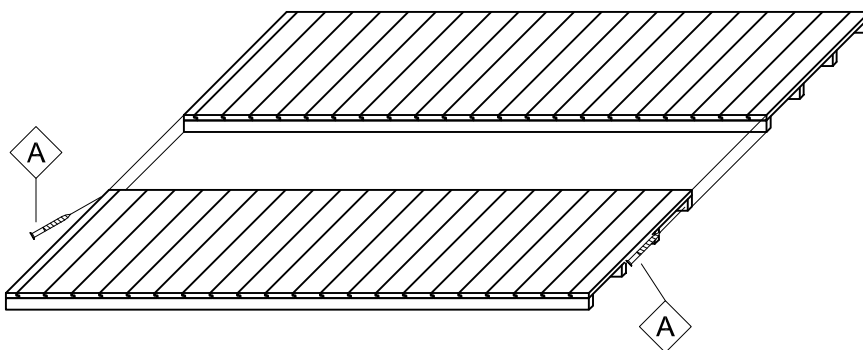

2

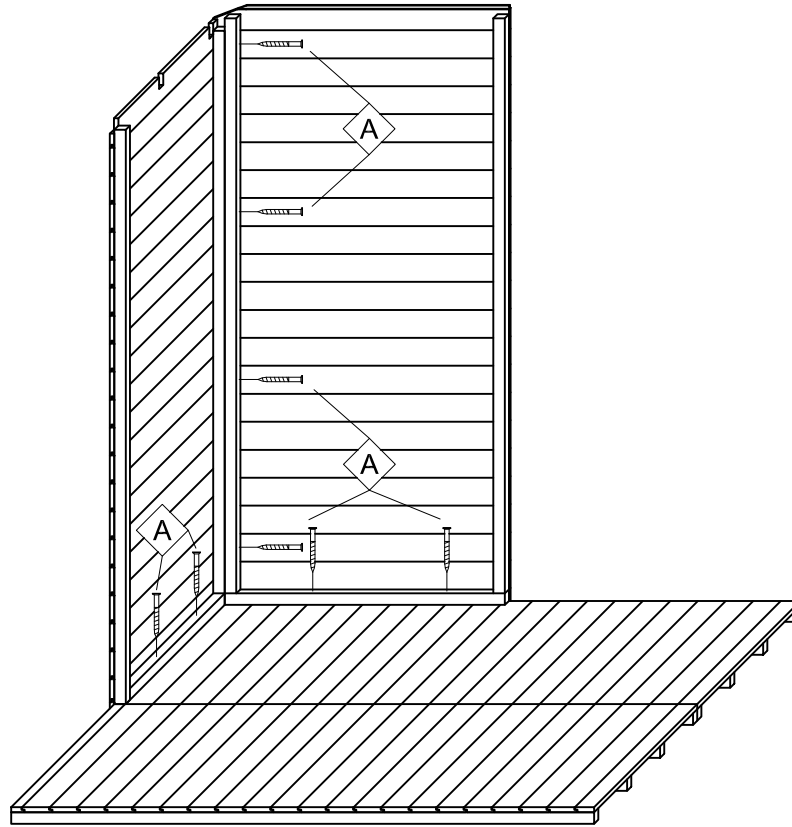

3

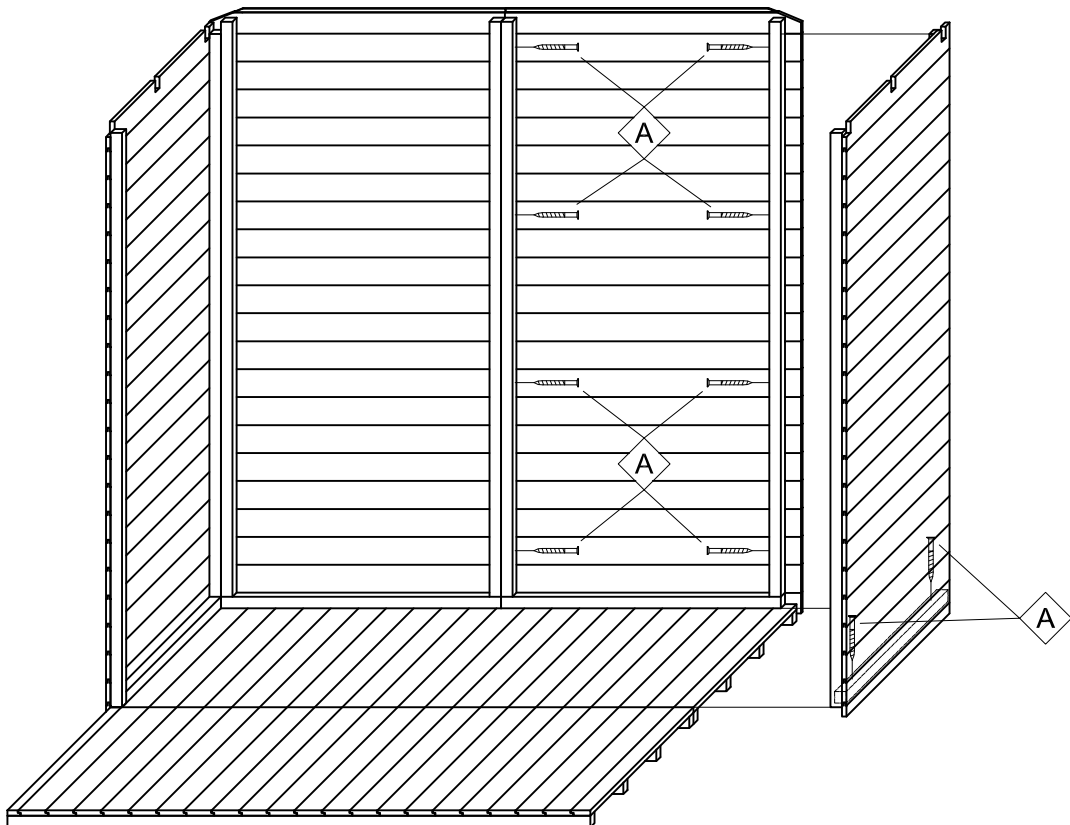

4

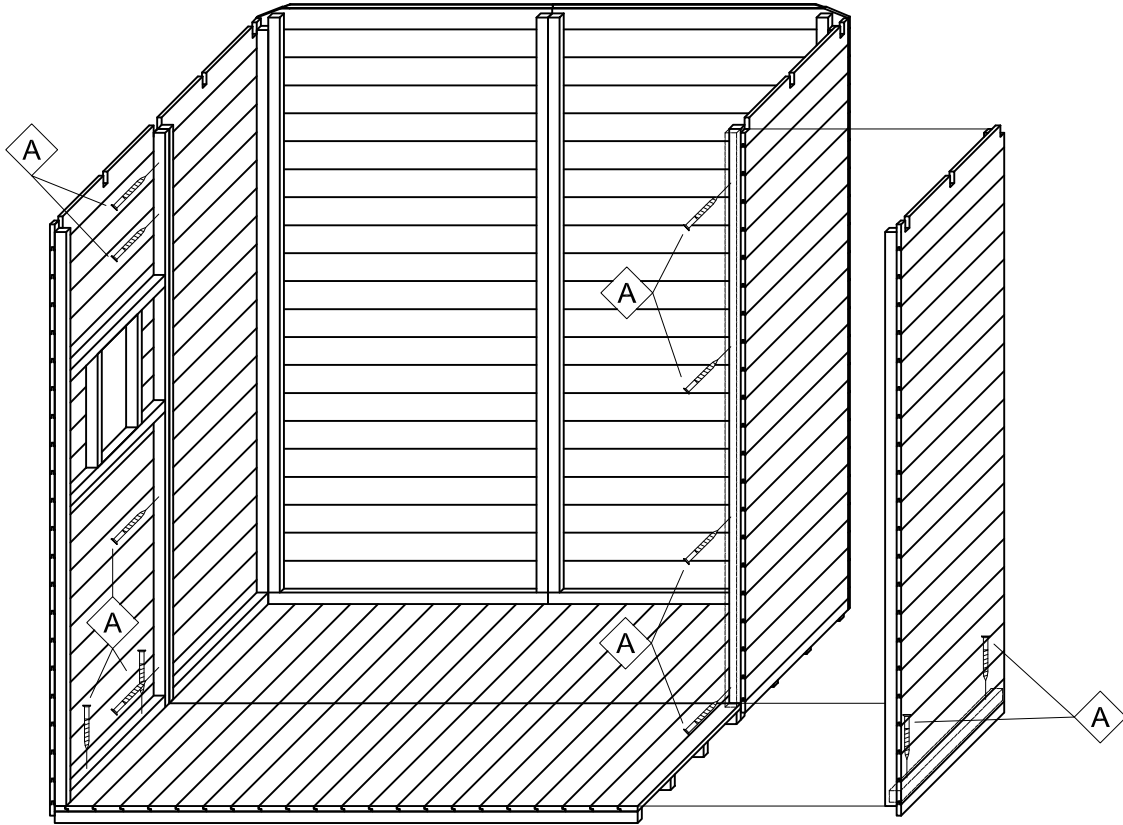

5

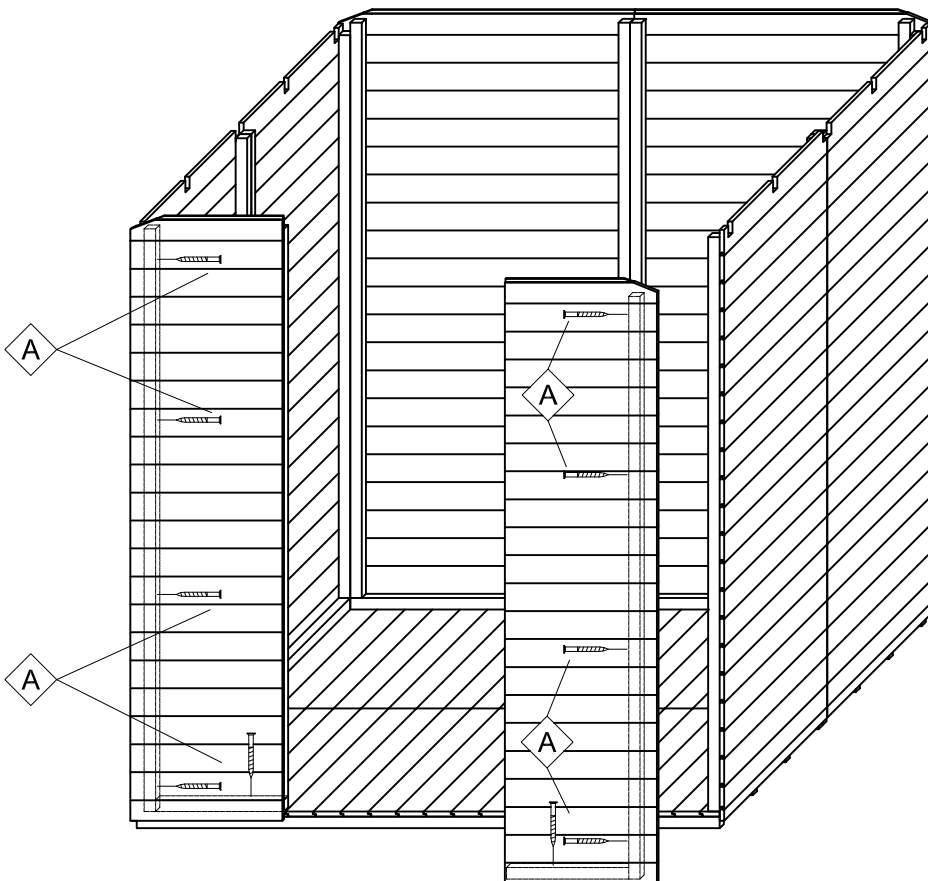

6

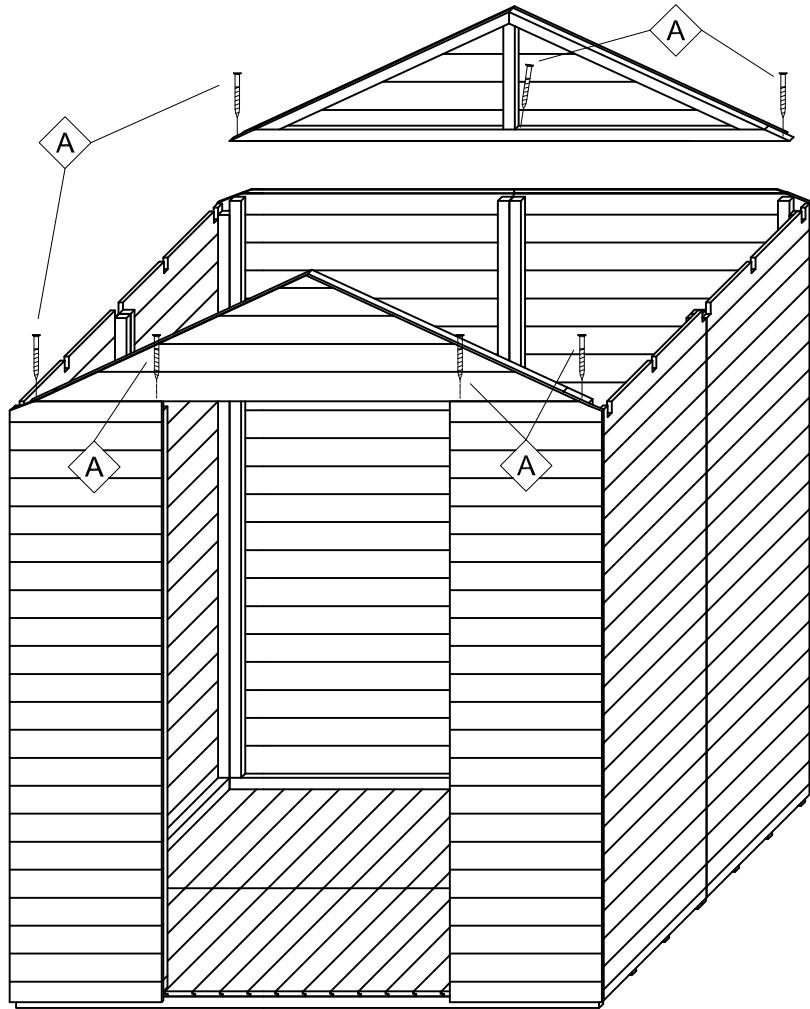

7

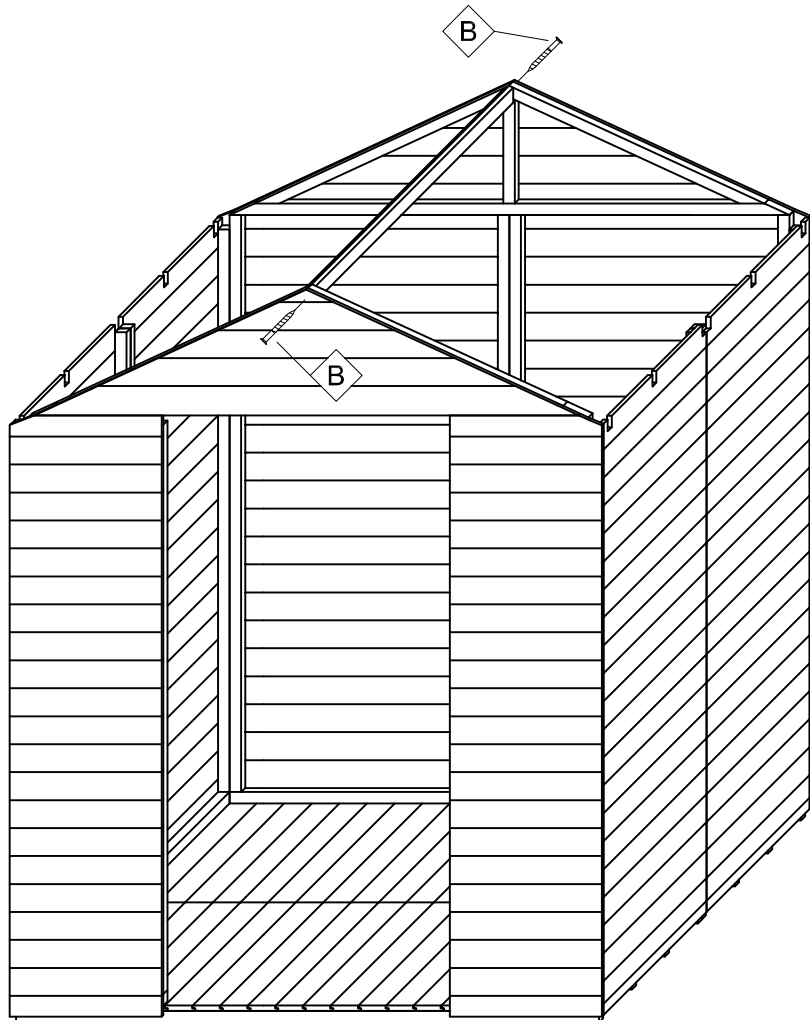

8

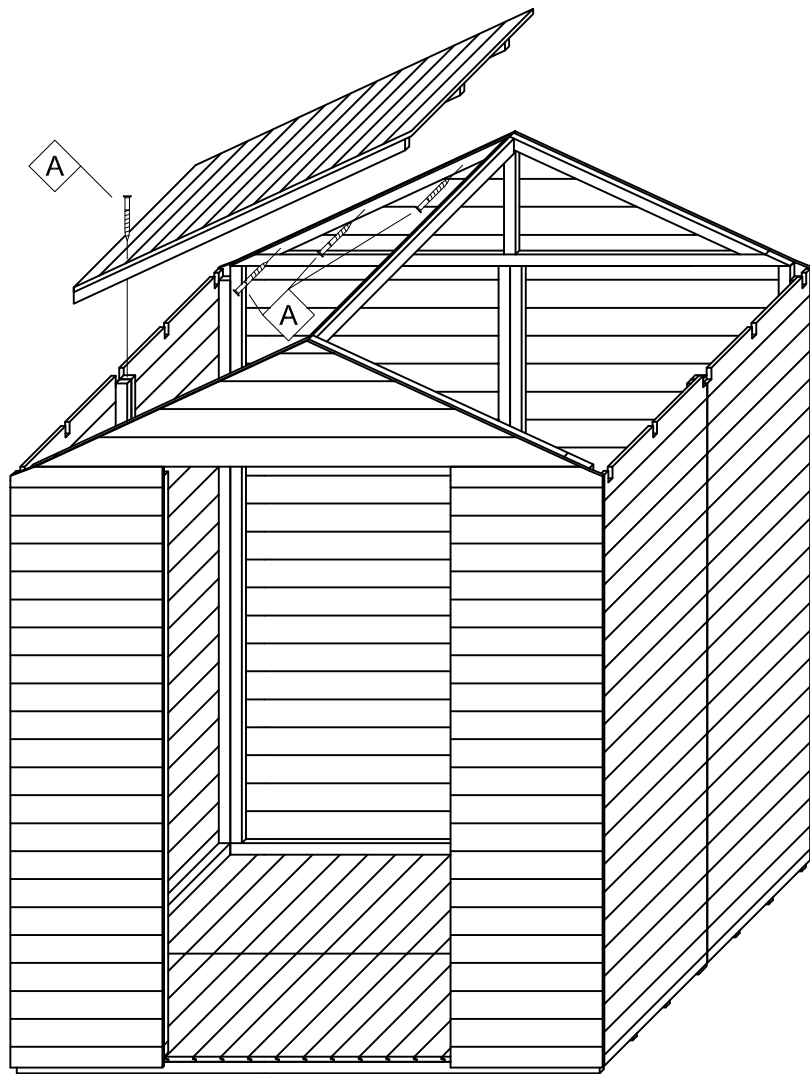

9

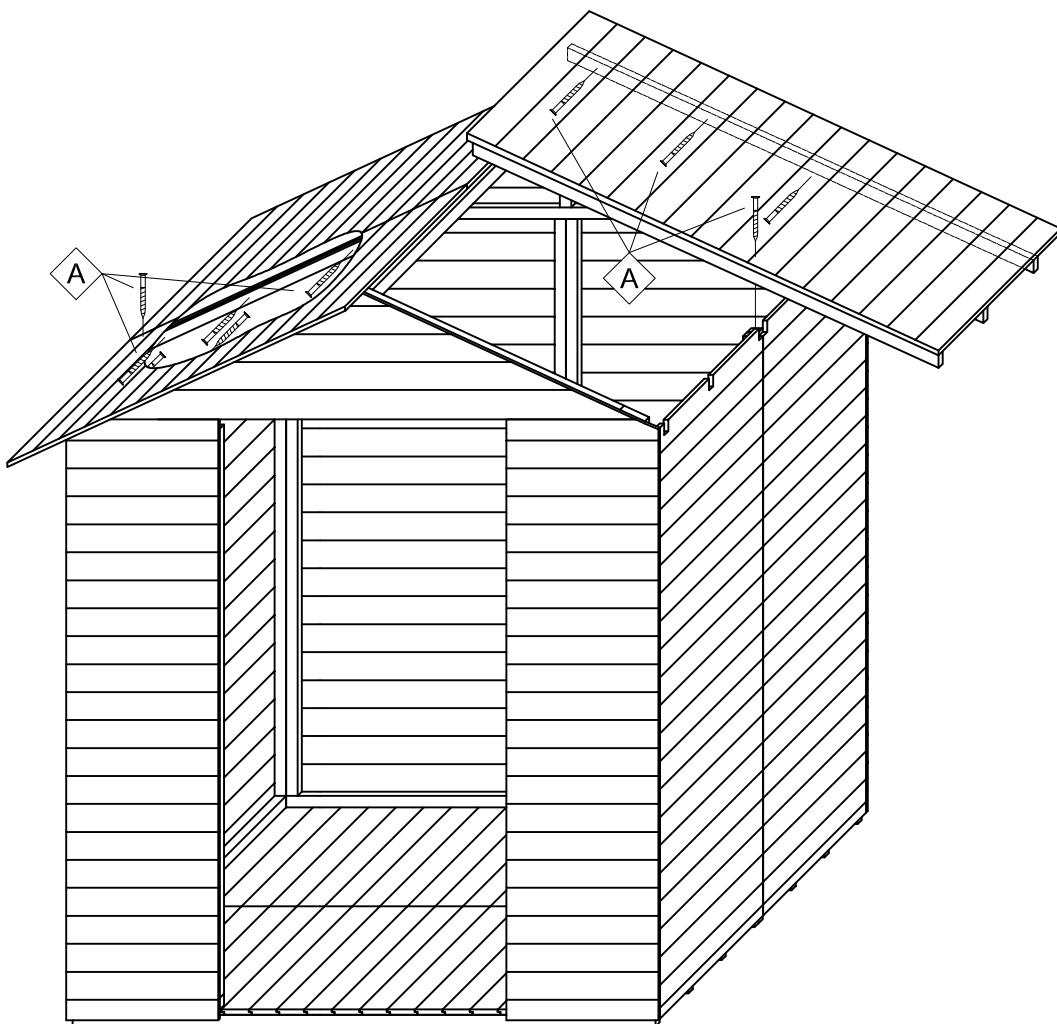

10

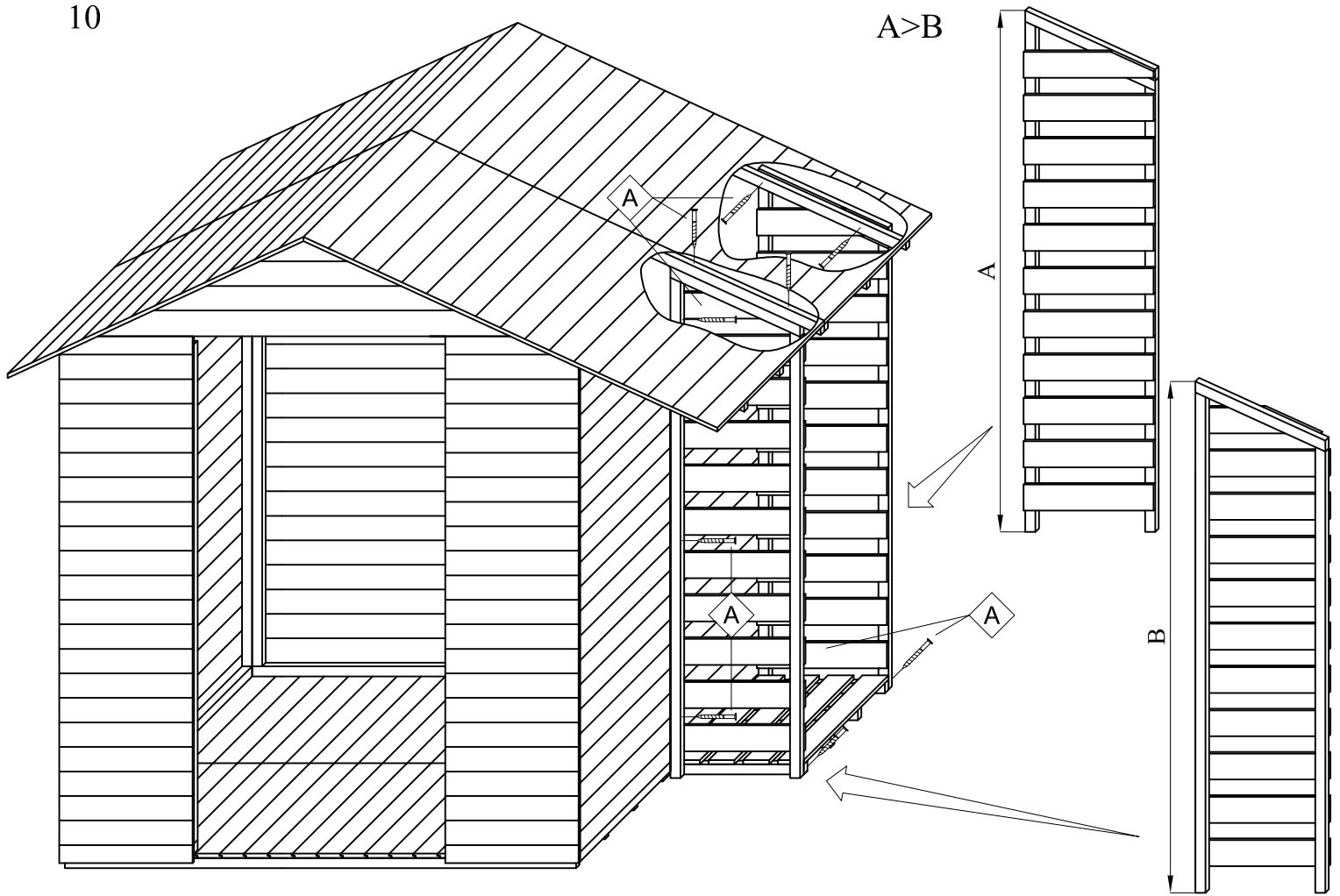

11

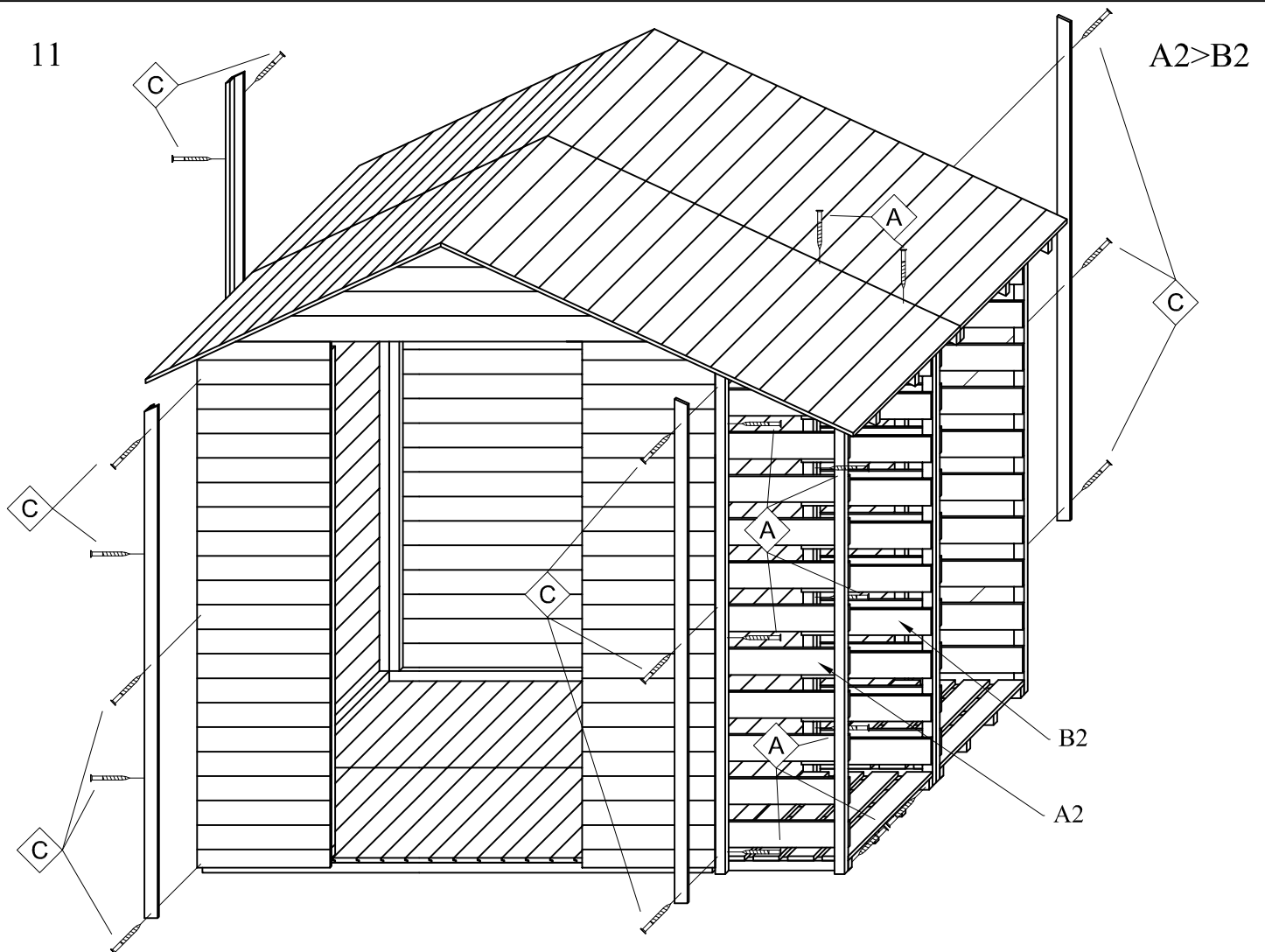

12

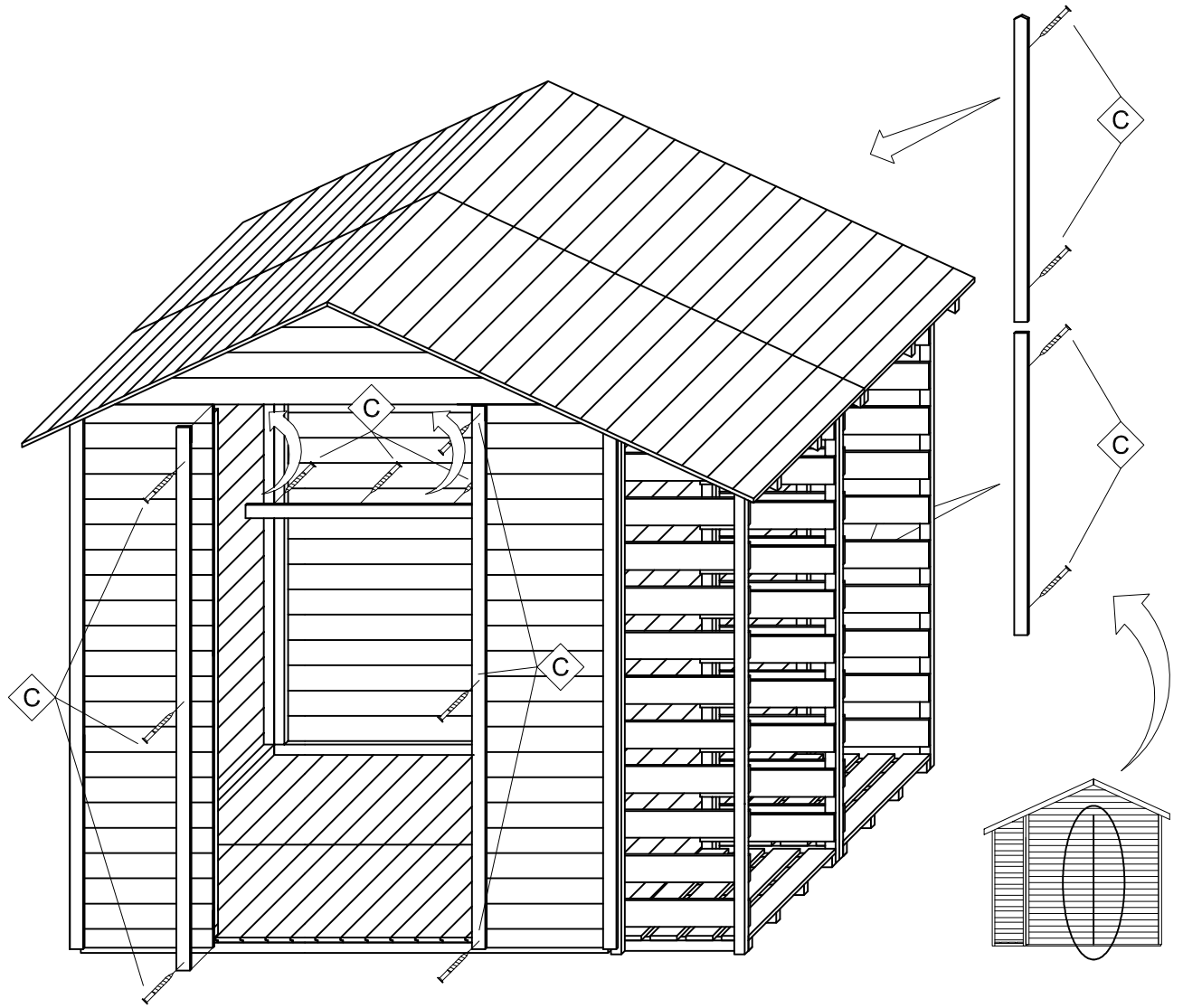

13

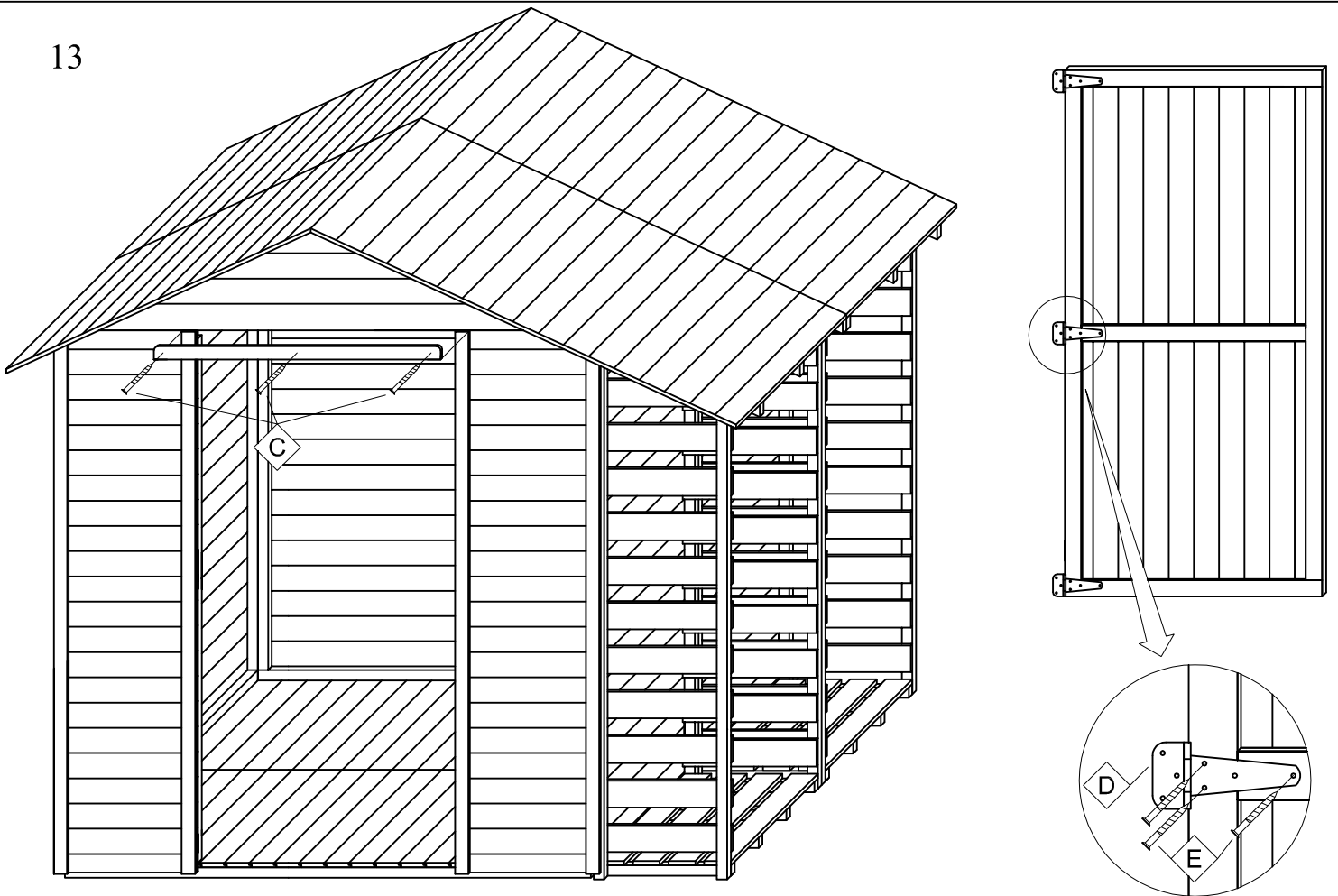

14

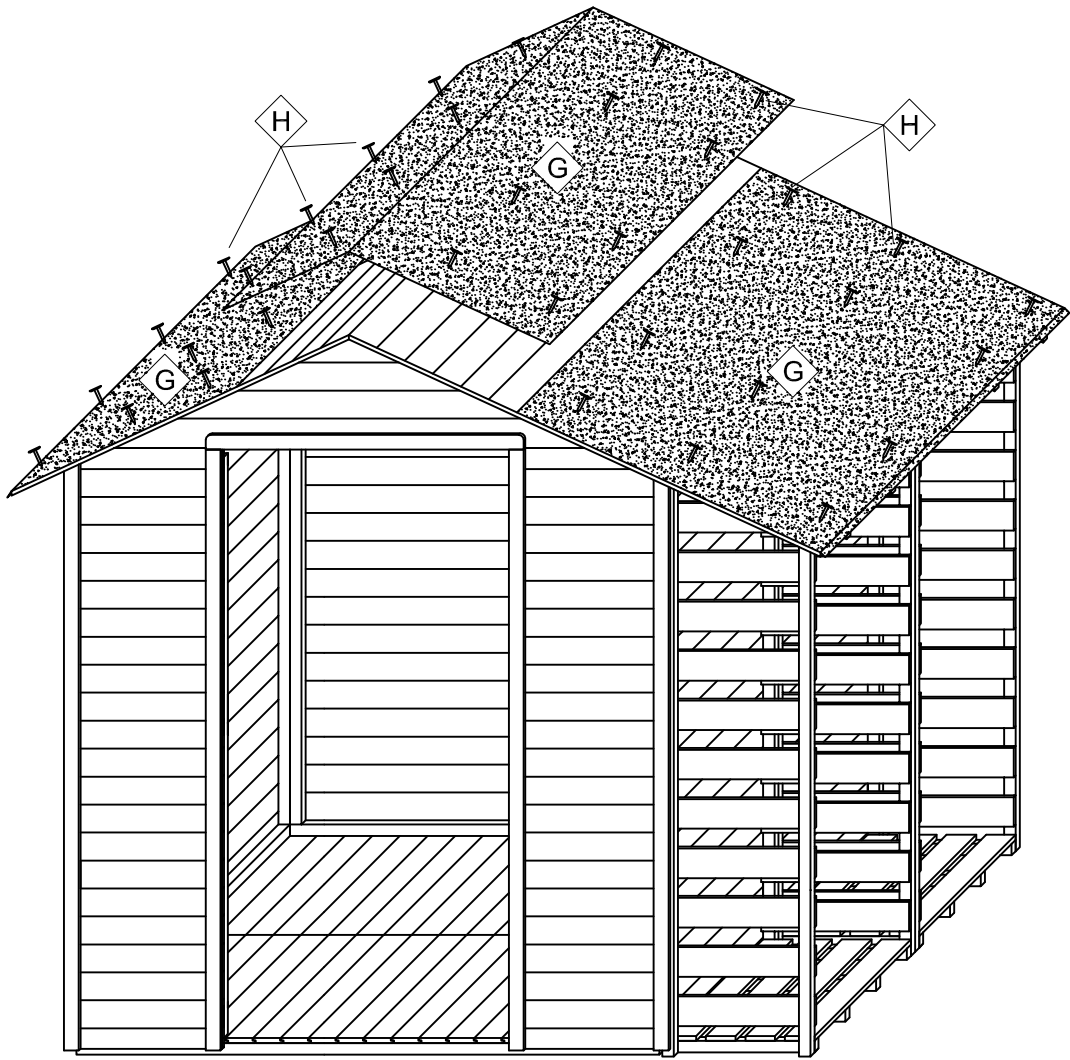

15

